



НАЧИН НА МОНТАЖ НА СИСТЕМИТЕ:

GEMINI 4, GEMINI 10, COMFORT 10, MAXIM 18 Frame

GEMINI 4, GEMINI 10, COMFORT 10

ВИСОЧИНА НА ВРАТА

$$h = H - 44 \text{ mm}$$

MAXIM 18 Frame

ВИСОЧИНА НА ВРАТА

$$h = H - 40 \text{ mm}$$

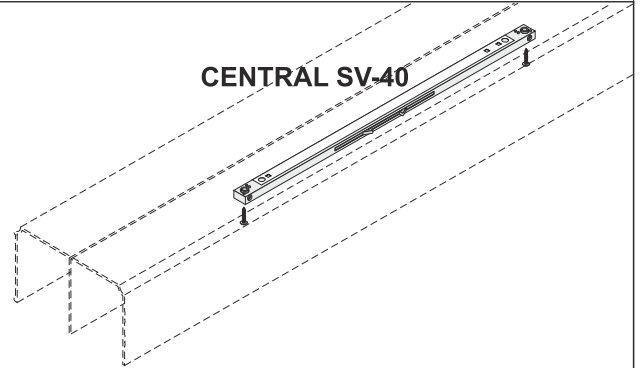
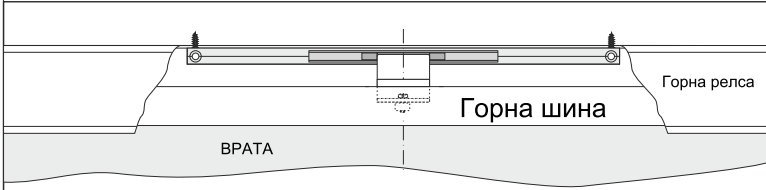

ВАЖНО !!!
ПРЕДИ ПОСТАВЯНЕТО НА ВРАТАТА
НАГЛАСЕТЕ ПАЛЕЦА !!!

System GEMINI 4, GEMINI 10

СИМЕТРИЧНА КОЛИЧКА

НЕСИМЕТРИЧНА КОЛИЧКА

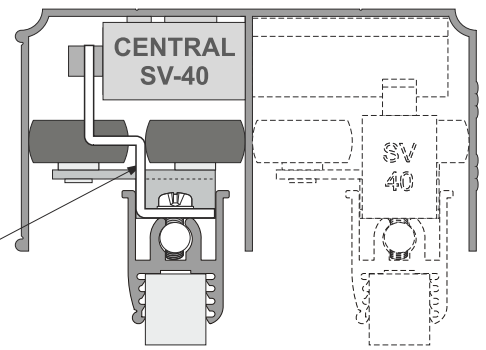
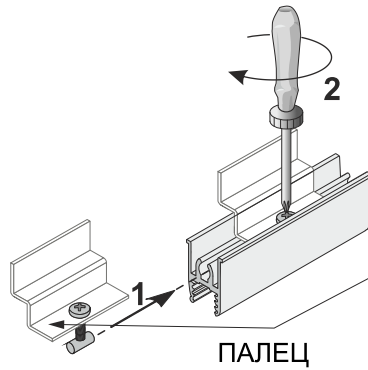
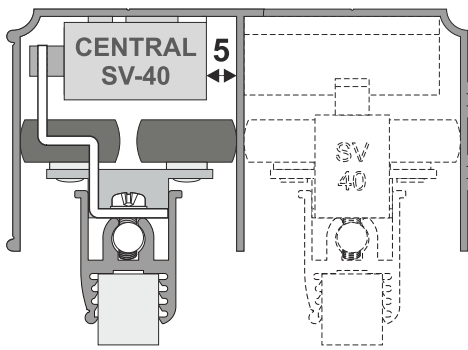

System COMFORT 10

СИМЕТРИЧНА КОЛИЧКА

НЕСИМЕТРИЧНА КОЛИЧКА

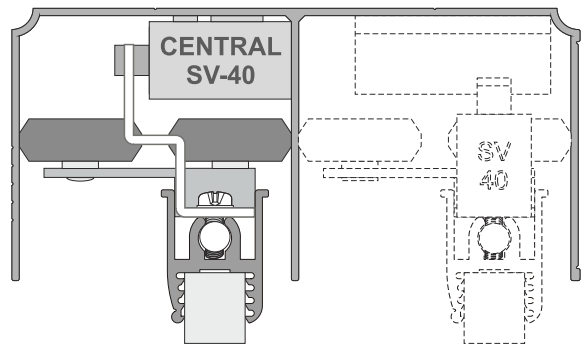
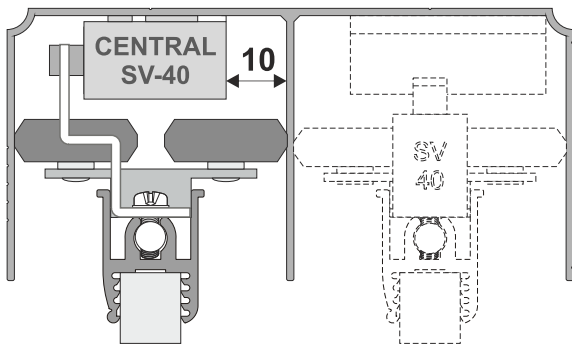

System MAXIM 18 Frame

СИМЕТРИЧНА КОЛИЧКА

НЕСИМЕТРИЧНА КОЛИЧКА

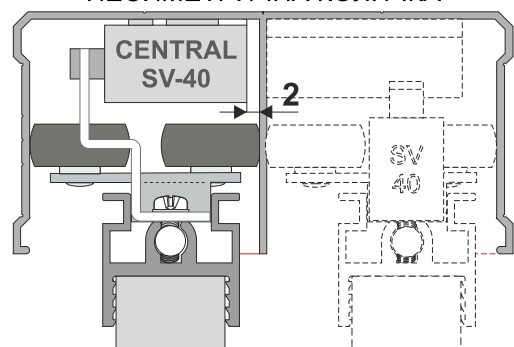
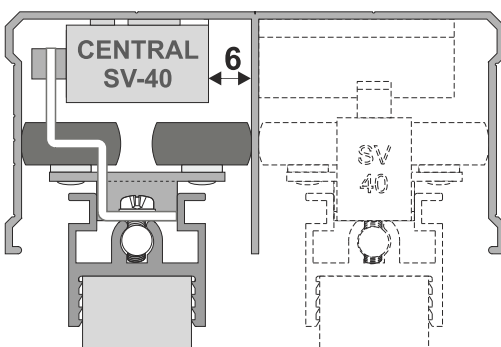



НАЧИН НА МОНТАЖ НА СИСТЕМИТЕ: GEMINI 18, COMORT 18, MAXIM 18 Board

GEMINI 18, COMFORT 18

MAXIM 18 Board

ВИСОЧИНА НА ВРАТА

$$h = H - 44 \text{ mm}$$

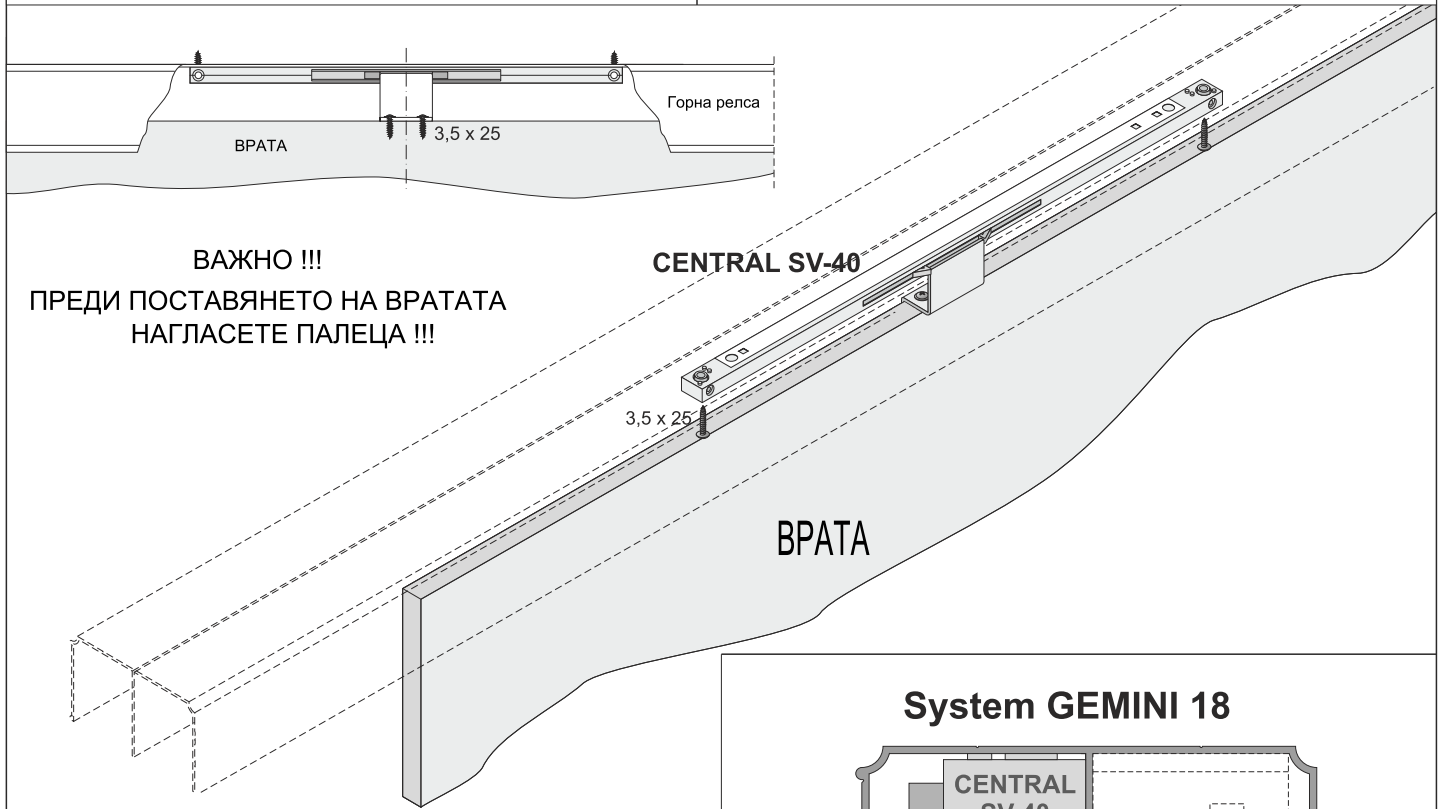

System GEMINI 18

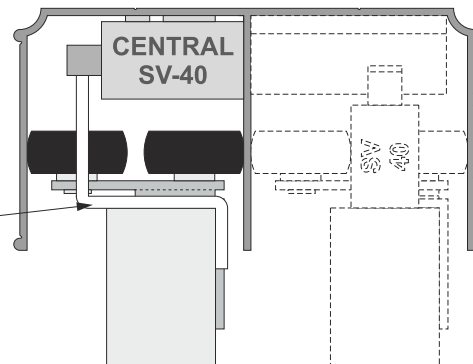

ПАЛЕЦ

System MAXIM 18 BOARD

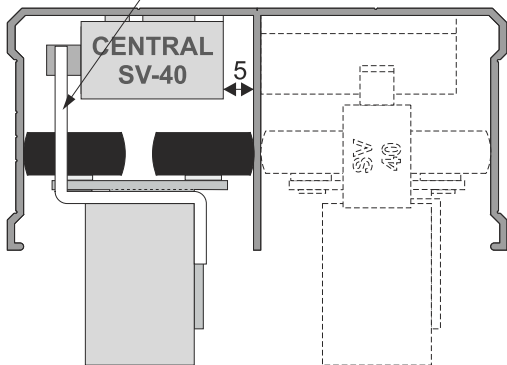

System COMFORT 18

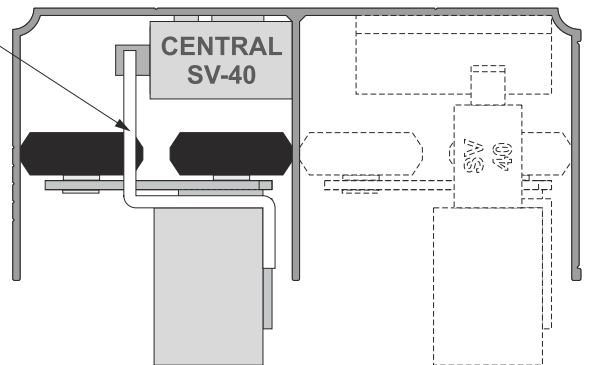

ЕЛЕМЕНТИ

МЕХАНИЗЪМ ЗА ПЛАВНО ЗАТВАРЯНЕ **Sevromatic CENTRAL SV-40 (40 kg)**

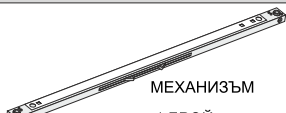
| | | | | |
|--|--|--|--|--|
|  МЕХАНИЗЪМ 1 БРОЙ |  ПАЛЕЦ 10 MM 1 БРОЙ | ПАТРОНЧЕ - 1 szt. ВИНТ - 1 szt. ШАЙБА - 1 szt. |  ПАЛЕЦ 18 MM 1 БРОЙ |  wkreń 3,5 x 25 - 4 szt. |
|--|--|--|--|--|